

**MODEL:** PJ-015BH-SMT | **DESCRIPTION:** DC POWER JACK

**FEATURES**

- surface mount
- vertical orientation
- rated up to 5 A



**SPECIFICATIONS**

parameter	conditions/description	min	typ	max	units
rated input voltage			16		Vdc
rated input current				5	A
contact resistance <sup>1</sup>	between terminal and mating plug between terminal in a closed circuit			50 30	mΩ mΩ
insulation resistance	at 500 Vdc	100			MΩ
voltage withstand	at 50/60Hz for 1 minute			500	Vac
insertion/withdrawl force		0.3		3	kg
terminal strength	any direction for 10 seconds			500	g
operating temperature		-25		85	°C
life			5,000		cycles

Notes: 1. When measured at a current of less than 100 mA / 1 kHz

**SOLDERABILITY**

parameter	conditions/description	min	typ	max	units
reflow soldering	see reflow profile	255	260	265	°C

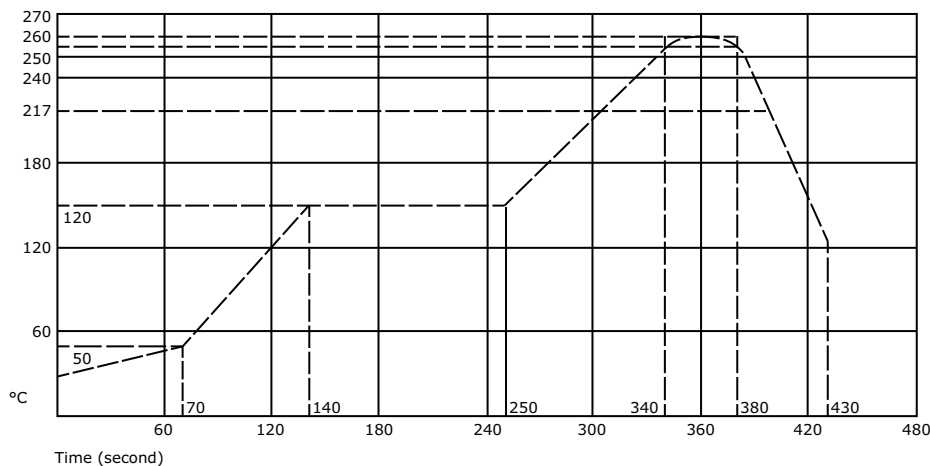

## MECHANICAL DRAWING

units: mm

TOLERANCE:  
 X.X ±0.2mm  
 X.XX ±0.1mm  
 X.XXX ±0.05mm

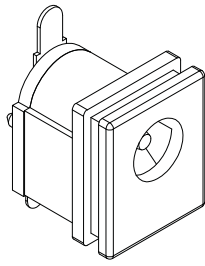

	MATERIAL	PLATING
center pin	copper	nickel
terminal 1	brass	silver
terminal 2	copper alloy	silver
terminal 3	brass	silver
plastic	PA6T	

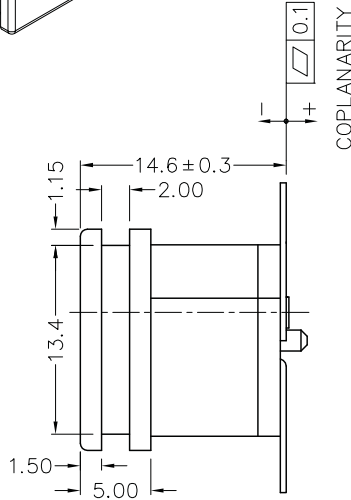
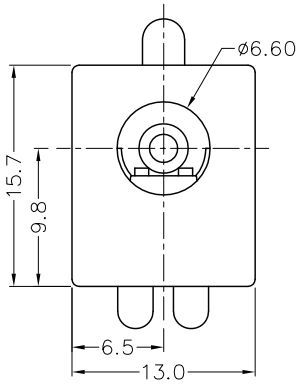

COPLANARITY

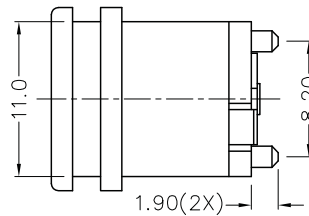
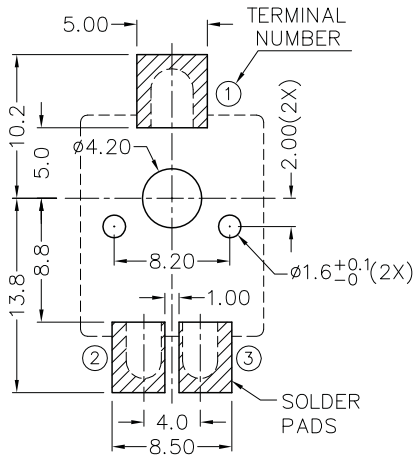
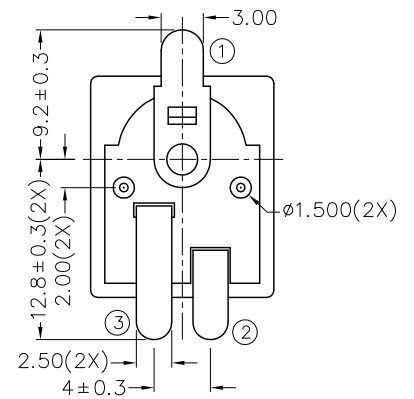

RECOMMENDED  
 SOLDER PAD LAYOUT  
 (TOP VIEW)

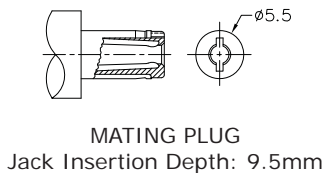

Schematic	
Model	Center Pin
PJ-015BH-SMT	$\phi 2.5$ mm

## REVISION HISTORY

---

rev.	description	date
1.0	initial release	07/18/2012

The revision history provided is for informational purposes only and is believed to be accurate.



**Headquarters**  
20050 SW 112th Ave.  
Tualatin, OR 97062  
**800.275.4899**

Fax 503.612.2383  
**cui.com**  
techsupport@cui.com

CUI offers a one (1) year limited warranty. Complete warranty information is listed on our website.

CUI reserves the right to make changes to the product at any time without notice. Information provided by CUI is believed to be accurate and reliable. However, no responsibility is assumed by CUI for its use, nor for any infringements of patents or other rights of third parties which may result from its use.

CUI products are not authorized or warranted for use as critical components in equipment that requires an extremely high level of reliability. A critical component is any component of a life support device or system whose failure to perform can be reasonably expected to cause the failure of the life support device or system, or to affect its safety or effectiveness.